



PA 445

Current loop wall display with output relays

Functional range

- ▶ Free adjustable display
- ▶ Switching mode, hysteresis, switching outputs damping
- ▶ Mains supply 230 V AC
- ▶ Auxiliary power supply 24 V DC for pressure transmitters up to 25 mA

Product characteristics

- ▶ 3digit LED high luminosity display
- ▶ Input 0/4 – 20 mA
- ▶ Protection IP 65

Optional versions

- ▶ 1x or 2 x relay, switching contact 250 V AC, 4 A

PA 445 is a 3-digit wall display of current loop 0 / 4-20 mA with red LED display and own mains-connectable power supply. The offer includes a variant with 1 or 2 output relays with a changeover contact for signaling limit states.

There are 3 control buttons for configuring the display hidden under the lid. The display can be pulled out of the connector and rotated 180 °, so the display can also be used for mounting position with the glands at the top.

Main areas of use

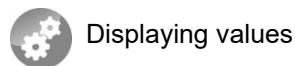

Displaying values



Power supply / Display	
Power supply	230 V AC (+10 -15%), 48 - 65 Hz
Power input	Max. 3 VA
Display	-99 ~ 0 ~ 999 3-digit red LED with high luminosity, digit height 14 mm
Decimal point	Programmable
Distinction	According to the position of the decimal point
Input	
Input signal	Current transducer 4 ~ 20 mA
Outputs	
Outputs	Switching, 2x relay, Switching contact 250 V AC, 4 A
Parameters	
Design	Wall mounted
Dimensions	131 x 95 x 40 mm (w x h x d)
Keyboard	3 keys, inside the unit after removing the lid
Weight	0,25 kg
Auxiliary power supply	24 V DC for power supply of transmitter up to 25 mA
Conditions	
Work temperature / storage	0 ~ 50 °C/ -30 ~ 70 °C
setting time	Within 5 minutes after switching on
Performance	Device of protection class II
Protection	IP 65
Connecting	Connector terminal block (cross-section 0,5-1 mm ²)
Accuracy	± 0,3 % of range
Data backup	Electrical (EEPROM)
Electromagnetic compatibility	
Electrical safety	ČSN EN 61326-1: 2013 including changes ČSN EN 61010-1 ed.2: 2011 including changes Overvoltage category III, degree of pollution 2

Dimensions (in mm)

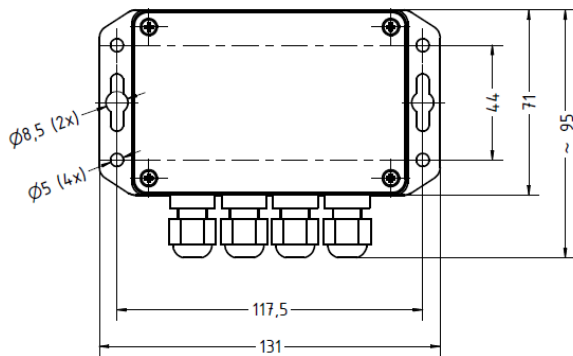

Frontal view

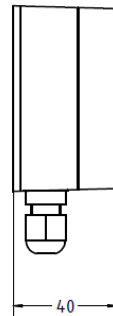

Side view

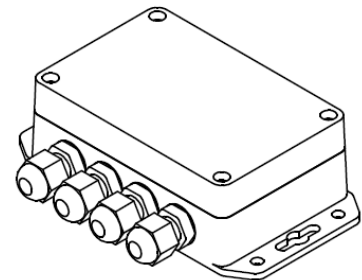

Overall view

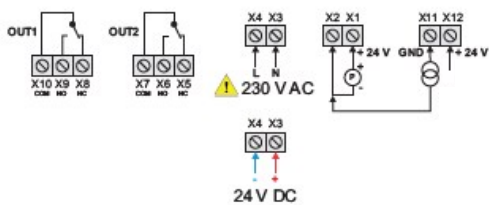

connection

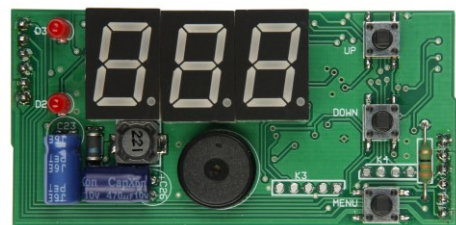

display board with control buttons

Ordering code PA 445

23.08.2024

PA 445

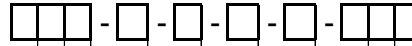

Version										
Standard version	8	5	1							
Input										
current input - transmitter 4 ... 20 mA/2-wire				1						
Contact output										
1 relay (contacts 250 VAC, 4 A)					1					
2 relays (contacts 250 VAC, 4 A)					2					
Power supply										
230 VAC						1				
Display										
LED - Red							1			
Special version										
Standard								0	0	1
Customer								X	X	X

0,-...without additional charge

On request...in accordance with the producer

This data sheet contains product specification; properties are not guaranteed.

Subject to change without notice.

This document contains the specification for ordering the product;

detailed technical parameters of the product and its possible variants are given in the data sheet.

BD SENSORS reserves the right to change sensor specifications without further notice.



BD SENSORS s.r.o.
Hradišťská 817
CZ – 687 08 Buchlovice

Tel.: +420 572 411 011

www.bdsensors.cz
info@bdsensors.cz

The company BD SENSORS s.r.o. is certified by Bureau Veritas Czech according to the standard ISO 9001.

