



DS 401

Intelligent Electronic Pressure Switch Stainless Steel

Ceramic Sensor

accuracy according to EN IEC 62828-2:
0.5 % span

Nominal pressure

from 0 ... 400 mbar up to 600 bar

Contacts

1 or 2 independent PNP contacts,
freely configurable

Analogue output

2-wire: 4 ... 20 mA

3-wire: 4 ... 20 mA

others on request

Special characteristics

- ▶ indication of measured values on a 4-digit LED display
- ▶ rotatable and configurable display module

Optional versions





- ▶ **IS-version**
Ex ia = intrinsically safe for gases
- ▶ pressure port PVDF
- ▶ customer specific versions

The electronic pressure switch DS 401 is the successful combination of

- ▶ intelligent pressure switch
- ▶ digital display

and has been specially designed for universal usage in industry applications; with flush diaphragm the DS 401 is suitable for the usage in viscous, pasty or highly contaminated media. The rotatable stainless steel housing is predestined for rough conditions and difficult installing conditions, caused by the high functionality and robustness. As standard the DS 401 offers a PNP contact and is optionally available with a second, independent contact. Additionally the DS 401 could be equipped with an analogue output

Preferred areas of use are

-  Plant and Machine Engineering
-  Environmental Engineering
(water – sewage – recycling)
-  Water
-  Hydraulic Oil



Input pressure ranges																		
Nominal pressure gauge [bar]	-1...0	0.4	0.6	1	1.6	2.5	4	6	10	16	25	40	60	100	160	250	400	600
Nominal pressure abs. [bar]	-	-	0.6	1	1.6	2.5	4	6	10	16	25	40	60	100	160	250	400	600
Level gauge [mH ₂ O]	-	4	6	10	16	25	40	60	100	160	250	400	600	-	-	-	-	-
Overpressure [bar]	4	1	2	2	4	4	10	10	20	40	40	100	100	200	400	400	600	800
Burst pressure ≥ [bar]	7	2	4	4	5	5	12	12	25	50	50	120	120	250	500	500	650	880
Vacuum resistance	P _N ≥ 1 bar: unlimited vacuum resistance P _N < 1 bar: on request																	

Contact ¹	
Number, type	standard: 1 PNP contact option: 2 independent PNP contacts
Max. switching current	4 ... 20 mA / 2- and 3-wire: contact rating 125 mA, short-circuit resistant; V _{Switch} = V _S - 2V
Accuracy of contacts ²	≤ ± 0.5 % span
Repeatability	≤ ± 0.2 % span
Switching frequency	2-wire: max. 10 Hz / 3-wire: 50 Hz
Switching cycles	> 100 x 10 ⁶
Delay time	0 ... 100 sec

¹ with Ex-protection max. 1 contact possible

² accuracy according to EN IEC 62828-2- limit point adjustment (non-linearity, hysteresis, repeatability)

Analogue output (optionally) / Supply	
2-wire current signal	4 ... 20 mA / V _S = 13 ... 36 V _{DC} permissible load: R _{max} = [(V _S - V _{S min}) / 0.02 A] Ω response time: < 10 msec
2-wire current signal, Ex-protection	4 ... 20 mA / V _S = 15 ... 28 V _{DC} permissible load: R _{max} = [(V _S - V _{S min}) / 0.02 A] Ω response time: < 10 msec
3-wire current signal	4 ... 20 mA / V _S = 24 V _{DC} ± 10 % adjustable (turn-down of span 5:1) ³ permissible load: R _{max} = 500 Ω response time: < 30 msec
Accuracy ²	≤ ± 0.5 % span

³ with turn-down of span the analogue signal is adjusted automatically to the new measuring range

Thermal effects (Offset and Span) / Permissible temperatures	
Thermal error	≤ ± 0.2 % span / 10 K
in compensated range	-25 ... 85 °C
Permissible temperatures ⁴	medium: -40 ... 125 °C electronics / environment: -40 ... 85 °C storage: -40 ... 100 °C

⁴ for pressure port of PVDF the permissible temperature is -30 ... 60 °C

Electrical protection	
Short-circuit protection	permanent
Reverse polarity protection	no damage, but also no function
Electromagnetic compatibility	emission and immunity according to EN 61326

Mechanical stability	
Vibration	10 g RMS (25 ... 2000 Hz) according to DIN EN 60068-2-6
Shock	500 g / 1 msec according to DIN EN 60068-2-27

Materials	
Pressure port / housing	1.4404 (316L) PVDF (for P _N ≤ 60 bar, G1/2" open port)
Housing	stainless steel 1.4301 (304)
Housing cap	standard: plastic HDPE for option IS-protection: stainless steel 1.4301 (304)
Display housing	stainless steel 1.4301 (304)
Viewing glass	laminated safety glass
Seals	standard: FKM option: EPDM (P _N ≤ 160 bar), NBR others on request
Diaphragm	ceramics Al ₂ O ₃ 96 %
Media wetted parts	pressure port, seals, diaphragm

Explosion protection (only for 4 ... 20 mA / 2-wire)	
Approval AX4-DS 401	IBExU06ATEX1049 X zone 0: II 1G Ex ia IIC T4 G zone 20 : II 1D Ex ia IIIC T135°C Da
Safety technical maximum values	$U_i = 28\text{ V}$, $I_i = 93\text{ mA}$, $P_i = 660\text{ mW}$, $C \approx 0\text{ nF}$, $L_i \approx 0\text{ }\mu\text{H}$
Max. switching current ⁵	70 mA
Permissible temperatures for environment	in zone 0: -20 ... 60 °C with p_{atm} 0.8 bar up to 1.1 bar in zone 1 or higher: -25 ... 70 °C
⁵ the real switching current in the application depends on the power supply unit	
Miscellaneous	
Display	4-digit, 7-segment-LED display, visible range 37.2 x 11 mm; digit height 10 mm, range of indication -1999 ... +9999; accuracy 0.1 % \pm 1 digit; digital damping 0.3 ... 30 sec (programmable); measured value update 0.0 ... 10 sec (programmable)
Option oxygen application ⁶	for $P_N \leq 25\text{ bar}$: O-ring in FKM Vi 567 (with BAM-approval); permissible maximum values are 25 bar / 150°C
Current consumption (without contacts)	2-wire signal output current: max. 25 mA 3-wire signal output current: approx. 30 mA + signal current
Ingress protection	IP 67
Installation position	any
Weight	approx. 400 g
Operational life	> 100 x 10 ⁶ pressure cycles
CE-conformity	EMC Directive: 2014/30/EU Pressure Equipment Directive: 2014/68/EU (module A) ⁷
⁶ not possible with flush pressure ports	
⁷ This directive is only valid for devices with maximum permissible overpressure > 200 bar	
Wiring diagrams	
<p>2-wire-system (current)</p>	<p>3-wire-system (current / voltage)</p>
Pin configuration	
Electrical connections	M12x1 metal (5-pin)
Supply +	1
Supply -	3
Signal + (only 3-wire)	2
Contact 1	4
Contact 2	5
Shield	plug housing / pressure port
Electrical connections	
<p>M12x1 (5-pin)</p>	

DS 401

Electronic Pressure Switch

Technical Data

Design ⁸

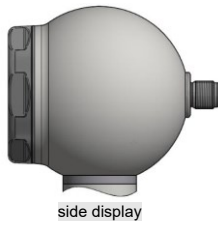

⁸ all designs in horizontal rotatable housing as standard

Mechanical connections (dimensions in mm)

standard

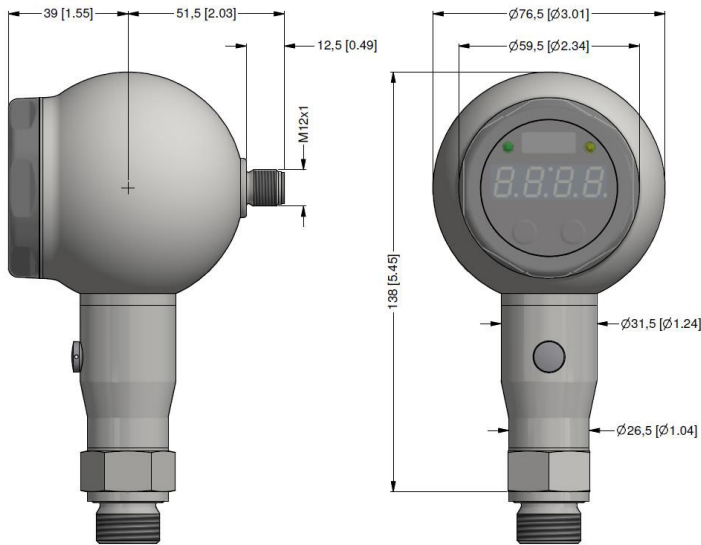

optionally

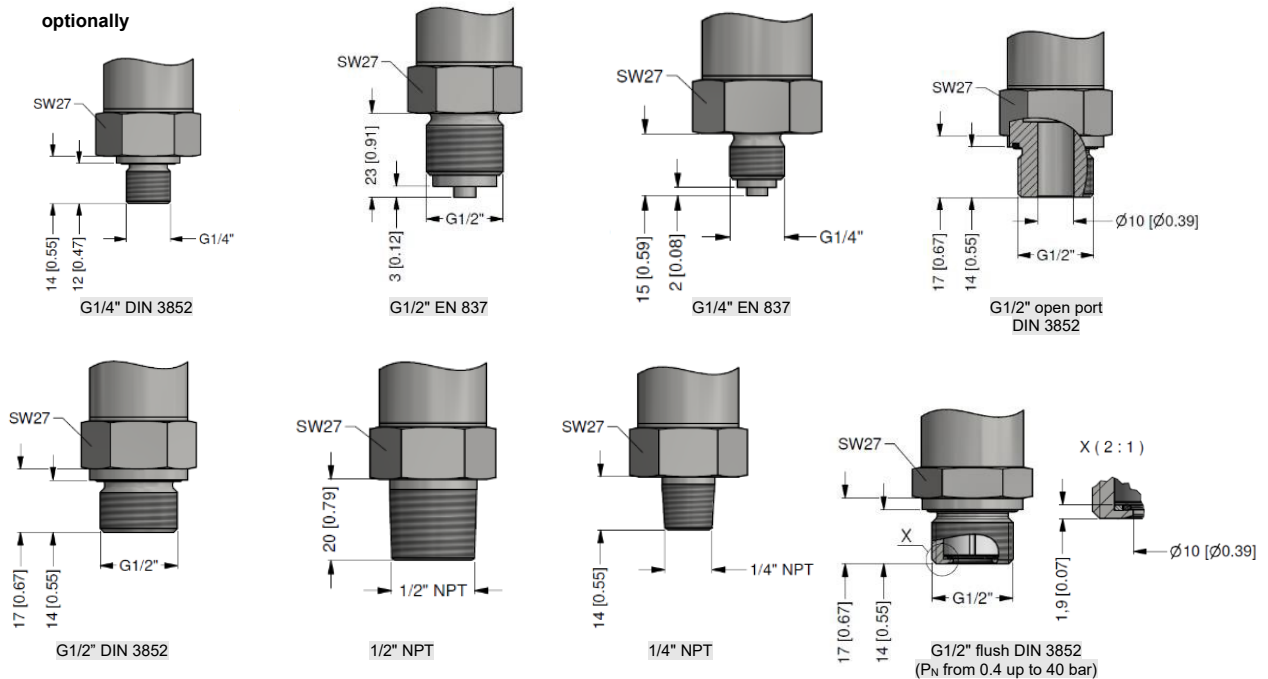

⇒ metric threads and other versions on request

This data sheet contains product specification. properties are not guaranteed. Subject to change without notice.

ORD. Code DS 401

15.01.2024

DS 401

Pressure																							
Gauge		7	A	2																			
Gauge m H ₂ O		7	A	E																			
Absolut		7	A	3																			
Input [bar]	[mH₂O]																						
0 ... 0,40	0 ... 4				4	0	0	0															
0 ... 0,60	0 ... 6				6	0	0	0															
0 ... 1	0 ... 10				1	0	0	1															
0 ... 1,6	0 ... 16				1	6	0	1															
0 ... 2,5	0 ... 25				2	5	0	1															
0 ... 4	0 ... 40				4	0	0	1															
0 ... 6	0 ... 60				6	0	0	1															
0 ... 10	0 ... 100				1	0	0	2															
0 ... 16	0 ... 160				1	6	0	2															
0 ... 25	0 ... 250				2	5	0	2															
0 ... 40	0 ... 400				4	0	0	2															
0 ... 60	0 ... 600				6	0	0	2															
0...100					1	0	0	3															
0...160					1	6	0	3															
0...250					2	5	0	3															
0...400					4	0	0	3															
0...600					6	0	0	3															
-1...0					X	1	0	2															
Customer					9	9	9	9															
Customer - underpressure					X	X	X	X															
Design																							
Stainless steel globe housing (side display)																				K	H		
Stainless steel globe housing (45° display)																				K	4		
Electrical output / Analog output																							
4 ... 20 mA / 2-wire																					1		
4 ... 20 mA / 3-wire																					7		
Intrinsic safety Ex ia 4 ... 20 mA / 2-wire (max. 1 switch. output) ¹																					E		
Customer																					9		
Contact																							
1 switching contact (version 3-wire only with 5-pin connector)																					1		
2 switching contacts (only with 5-pin connector) ¹																					2		
Accuracy																							
0,5 %																					5		
Customer																					9		
Electrical connection																							
Connector M12 x 1, 5-pin (IP 67) - metal																					N	1	1
Customer																					9	9	9
Mechanical connection																							
G 1/2" DIN 3852																					1	0	0
G 1/2" EN 837																					2	0	0
G 1/4" DIN 3852																					3	0	0
G 1/4" EN 837																					4	0	0
G 1/2 " DIN 3852 with flush sensor ²																					F	0	0
G 1/2" DIN 3852 open - housing PVDF (P _N ≤ 60 bar)																					H	0	0
1/2" NPT																					N	0	0
1/4" NPT																					N	4	0
Customer																					9	9	9
Seals																							
Viton (FKM)																						1	
EPDM ³																						3	
Customer																						9	
Pressure port																							
Stainless steel 1.4404 (316 L)																						1	
PVDF (P _N ≤ 160 bar) only with G 1/2" DIN 3852 open port H00 ⁴																							B
Customer																							9
Diaphragm																							
Ceramics Al ₂ O ₃ 96 %																							2
Customer																							9



BD SENSORS s.r.o.
Hradištská 817
CZ – 687 08 Buchlovice

Tel.: +420 572 411 011
Fax: +420 572 411 497

www.bdsensors.cz
info@bdsensors.cz



Společnost BD SENSORS s.r.o. je certifikována společností TÜV SÜD Czech dle normy ISO 9001.

Special version			
Standard	0	0	0
Oxygen application ⁵	0	0	7
Customer	9	9	9

0,-...without additional charge

On request...in accordance with the producer

Surcharges for calibration are not subject to any discounts. Subject to change.

This document contains the specification for ordering the product; detailed technical parameters of the product and its possible variants are given in the data sheet.

BD SENSORS reserves the right to change sensor specifications without further notice.

1 with IS version max. 1 contact is possible

2 G1/2" flush up to 25 bar and nominal pressure abs. on request

3 possible for nominal pressure ranges $p_N \leq 160$ bar

4 PVDF only with G1/2" DIN 3852 open pressure port (up to 60 bar); Ex-protection not possible; permissible medium temperature: -30 ... 60 °C

5 oxygen application with FKM-seal up to 25 bar possible



BD SENSORS s.r.o.
Hradištská 817
CZ – 687 08 Buchlovice

Tel.: +420 572 411 011
Fax: +420 572 411 497

www.bdsensors.cz
info@bdsensors.cz

Společnost BD SENSORS s.r.o. je certifikována společností TÜV SÜD Czech dle normy ISO 9001.

