

DMK 457

Pressure Transmitter for Shipbuilding and Offshore

Ceramic Sensor

accuracy according to EN IEC 62828-2:
0.5 % span



Nominal pressure

from 0 ... 400 mbar up to 0 ... 600 bar

Output signals

2-wire: 4 ... 20 mA
others on request

Special characteristics

- ▶ LR-certificate (Lloyd's Register)
- ▶ DNV - Approval (Det Norske Veritas)
- ▶ ABS-certificate (American Bureau of Shipping)
- ▶ CCS-certificate (China Classification Society)
- ▶ pressure port in CuNiFe (sea water resistant)
- ▶ oxygen application

Optional versions

- ▶ IS-version
Ex ia = intrinsically safe
for gases and dusts

The pressure transmitter DMK 457 with ceramic sensor has been designed for typical applications in shipbuilding and offshore constructions as alternative to our pressure transmitter DMP 457 with piezoresistive stainless steel sensor.

In combination with the copper-nickel-alloy the DMK 457 is suitable for seawater, e.g. level measurement in ballast tanks, etc.

Preferred areas of use are

- Drives
- Compressors
- Boiler
- Pneumatic control systems
- Oxygen applications
- Fuel and oil#
- Water and sea water



Input pressure range																		
Nominal pressure gauge [bar]	-1 ... 0	0.4	0.6	1	1.6	2.5	4	6	10	16	25	40	60	100	160	250	400	600
Nominal pressure abs. [bar]	-	-	0.6	1	1.6	2.5	4	6	10	16	25	40	60	100	160	250	400	600
Level gauge / abs. [mH ₂ O]	-	-	6	10	16	25	40	60	100	160	250	400	600	-	-	-	-	-
Overpressure [bar]	4	1	2	2	4	4	10	10	20	40	40	100	100	200	400	400	600	800
Burst pressure ≥ [bar]	7	2	4	4	5	5	12	12	25	50	50	120	120	250	500	500	650	880
Vacuum resistance	p _N ≥ 1 bar: unlimited vacuum resistance p _N < 1 bar: on request																	

Output signal / Supply	
Standard	2-wire: 4 ... 20 mA / V _S = 8 ... 32 V _{DC}
Option IS-version	2-wire: 4 ... 20 mA / V _S = 10 ... 28 V _{DC}

Performance	
Accuracy ¹	EN IEC 62828-2: ≤ ± 0.5 % span
Permissible load	R _{max} = [(V _S - V _{S min}) / 0.02 A] Ω
Influence effects	supply: 0.05 % span / 10 V load: 0.05 % span / kΩ
Long term stability	≤ ± 0.3% span / year at reference conditions
Response time	< 10 msec

¹ accuracy according to EN IEC 62828-2 – limit point adjustment (non-linearity, hysteresis, repeatability)

Thermal effects (Offset and Span) / Permissible temperatures	
Thermal error	≤ ± 0.2 % span / 10 K in compensated range: -25 ... 85 °C
Permissible temperatures	medium: -40 ... 125 °C electronics / environment: -40 ... 85 °C storage: -40 ... 100 °C

Electrical protection	
Short-circuit protection	permanent
Reverse polarity protection	no damage, but also no function
Electromagnetic compatibility	emission and immunity according to - EN 61326 - DNV (Det Norske Veritas)

Mechanical stability	
Vibration	4 g (according to DNV: class B, curve 2 / basis: IEC 60068-2-6)

Materials	
Pressure port	Standard: stainless steel 1.4404 (316L) option ² : CuNi10Fe1Mn (sea water resistant) - for p _N ≤ 400 bar with mechanical connection G1/2" DIN 3852, G1/2" EN 837, G1/2" open port, G1/4" DIN 3852, G1/4" EN 837 - in combination with housing in CuNi10Fe1Mn (not with field housing) -
Housing	standard: stainless steel 1.4404 (316L) option ² : CuNi10Fe1Mn (sea water resistant) - in combination with pressure port in CuNi10Fe1Mn - option field housing: stainless steel 1.4404 (316L); with cable gland (CuNi10Fe1Mn not possible)
Cable sheath	TPE -U (flame-resistant, halogen free, increased resistance against oil and gasoline, resistant against salt, sea water, heavy oil)
Seals (media wetted)	standard: FKM option: FFKM (only for p _N ≤ 100 bar) others on request
Diaphragm	ceramic Al ₂ O ₃ 96 %
Media wetted parts	pressure port, seals, diaphragm

² IS-version on request

Category of the environment			
Lloyd's Register (LR) ³	EMV1, EMV2, EMV3, EMV4		number of certificate: 13/20055
Det Norske Veritas (DNV)	temperature:	D	number of certificate: TAA00001GR
	humidity:	B	
	vibration:	B	
	electromagnetic compatibility:	B	
	enclosure:	D	

³ for p_N ≤ 160 bar

Explosion protection			
Approvals DX19-DMK 457	IBExU 10 ATEX 1122 X / IECEx IBE 12.0027X zone 0: II 1G Ex ia IIB T4 Ga zone 20: II 1D Ex ia IIIC T135 °C Da		
Safety technical maximum values	$U_i = 28 \text{ V}$, $I_i = 93 \text{ mA}$, $P_i = 660 \text{ mW}$, $L_i \approx 0 \text{ }\mu\text{H}$ with field housing: $C_i = 105 \text{ nF}$ with cable outlet: $C_i = 84.7 \text{ nF}$ with ISO 4400: $C_i = 62.2 \text{ nF}$ the supply connections have an inner capacity of max. 90 nF (140 nF with field housing) to the housing		
Permissible temperatures for environment	in zone 0: -20 ... 60 °C with p_{atm} 0.8 bar up to 1.1 bar in zone 1 or higher: -40/-20 ... 70 °C		
Connecting cables (by factory)	cable capacitance: signal line/shield also signal line/signal line: 160 pF/m cable inductance: signal line/shield also signal line/signal line: 1 $\mu\text{H}/\text{m}$		
Miscellaneous			
Option oxygen application	for $p_N \leq 25 \text{ bar}$: O-ring in FKM Vi 567 (with BAM-approval) permissible maximum values are 25 bar/150° C		
Current consumption	max. 25 mA		
Weight	approx. 140 g (with ISO 4400)		
Installation position	any		
Operational life	100 million load cycles		
CE-conformity	EMC Directive: 2014/30/EU Pressure Equipment Directive: 2014/68/EU (module A) ⁴		
ATEX-directive	2014/34/EU		
⁴ This directive is only valid for devices with maximum permissible overpressure > 200 bar			
Wiring diagram			
2-wire-system (current)			
Pin configuration			
Electrical connection	ISO 4400 	field housing (clamp section: 2.5 mm ²) 	cable colours (IEC 60757)
Supply +	1	VS+	WH (white)
Supply -	2	VS-	BN (brown)
Shield	ground pin	GND	GYNE (green-yellow)

The manufacturer provides the EU declaration of conformity.

Calibration - All production undergoes output control, which is performed by comparison with standards. The traceability of standards and working gauges is ensured in accordance with Act No. 505/1990, as amended, on metrology.

The manufacturer offers the possibility to supply sensors calibrated in the calibration laboratory of BD SENSORS, accredited according to ČSN EN ISO / IEC 17025: 2018.

Electrical connections ⁵ (dimensions mm / in)

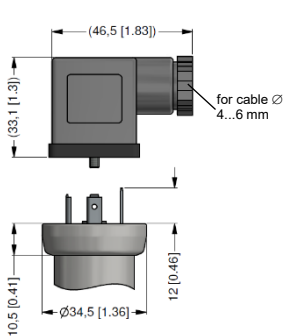

ISO 4400 - Code G10
(IP 65)

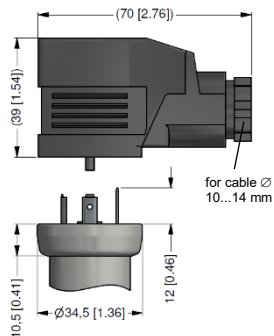

ISO 4400 - Code G00
(IP 65)

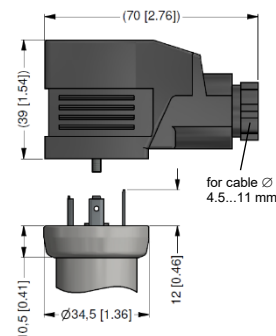

ISO 4400 - Code G01
(IP 65)

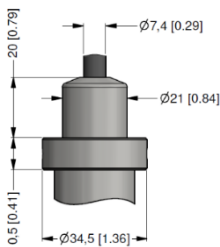

cable outlet ^{6, 7}
(IP 68)

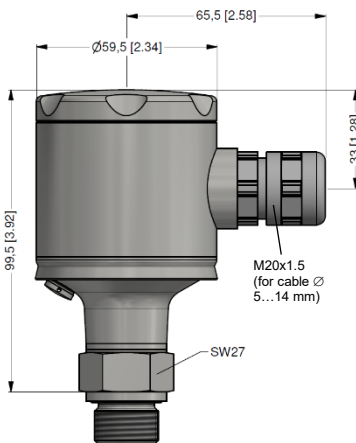

universal field housing
(IP 67)

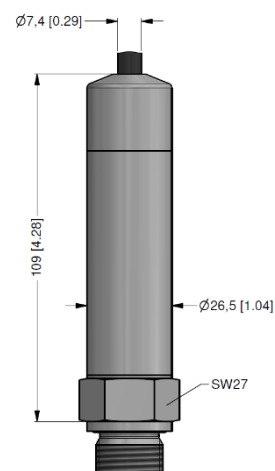

submersible version ⁷
(IP 68)

⁵ Generally shielded cable has to be used! Cable versions are delivered with shielded cable. For ISO 4400 the use of shielded cable is compulsory.

⁶ tested at 4 bar or 40 mH₂O for 24 hours

⁷ shielded cable with integrated air tube for atmospheric reference (for nominal pressure ranges absolute, the air tube is closed); different lengths available

Mechanical connection (dimensions mm / in)

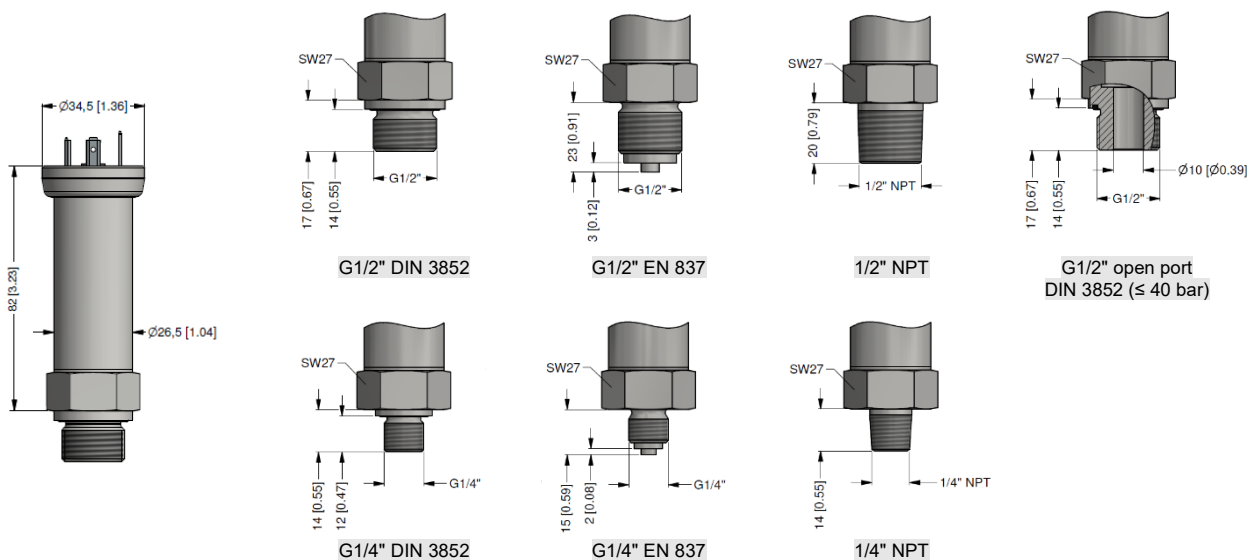

Ordering code DMK 457

09.02.2024

DMK 457

--	--	--	--	--	--	--	--	--	--	--	--	--	--	--	--	--	--	--	--

Pressure			
in bar, gauge		5 9 0	
in bar, absolute ¹		5 9 1	
Input	[mH ₂ O]	[bar]	
	0 ... 4	0 ... 0,4 ¹	4 0 0 0
	0 ... 6	0 ... 0,6	6 0 0 0
	0 ... 10	0 ... 1	1 0 0 1
	0 ... 16	0 ... 1,6	1 6 0 1
	0 ... 25	0 ... 2,5	2 5 0 1
	0 ... 40	0 ... 4	4 0 0 1
	0 ... 60	0 ... 6	6 0 0 1
	0 ... 100	0 ... 10	1 0 0 2
	0 ... 160	0 ... 16	1 6 0 2
	0 ... 250	0 ... 25	2 5 0 2
	0 ... 400	0 ... 40	4 0 0 2
	0 ... 600	0 ... 60	6 0 0 2
		0 ... 100	1 0 0 3
		0 ... 160	1 6 0 3
		0 ... 250	2 5 0 3
		0 ... 400	4 0 0 3
		0 ... 600	6 0 0 3
	-1 ... 0	-1 ... 0	X 1 0 2
Customer			
			9 9 9 9
Output			
4 ... 20 mA / 2-wire			1
Intrinsic safety 4 ... 20 mA / 2-wire			E
Customer			
			9
Accuracy			
0,5 %			5
Customer			
			9
Electrical connection			
Male and female plug ISO 4400 (female plug GL approbated, for cable Ø 4 ... 6 mm)			G 1 0
Male and female plug ISO 4400 (female plug GL approbated, for cable Ø 10 ... 14 mm)			G 0 0
Male and female plug ISO 4400 (female plug GL approbated) (for cable Ø 4,5 ... 11 mm)			G 0 1
Cable outlet / cable length specification needed (IP 68) ²			T R 3
+ TPE-U cable / 1 m			
Submersible version with TPE-U-cable (cable not included in price) ²			T S 3
+ TPE-U cable / 1 m			
Customer			
			9 9 9
Mechanical connection			
G1/2" DIN 3852			1 0 0
G 1/2" EN 837			2 0 0
G1/4" DIN 3852			3 0 0
G1/4" EN 837			4 0 0
M 20 x 1,5 DIN 3852			5 0 0
M 20 x 1,5 EN 837			8 0 0
G 1/2" DIN 3852 open port (P _N ≤ 40 bar)			H 0 0
1/2" NPT			N 0 0
1/4" NPT			N 4 0
Customer			
			9 9 9
Seals			



Viton (FKM)	1				
FFKM (only for $P_N \leq 100$ bar)	7				
Customer	9				
Pressure port					
Stainless steel 1.4404 (316L)	1				
Copper-nickel-alloy (CuNi10Fe1Mn) (only mech.con. H00) ³	K				
Customer	9				
Diaphragm					
Ceramic Al ₂ O ₃ 96 %		2			
Customer		9			
Special version					
Standard			0	0	0
Oxygen application (with FKM seal possible up to 25 bar)			0	0	7
Customer			9	9	9

0,-...without additional charge

On request...in accordance with the producer

Surcharges for calibration are not subject to any discounts. Subject to change.

This document contains the specification for ordering the product; detailed technical parameters of the product and its possible variants are given in the data sheet. BD SENSORS reserves the right to change sensor specifications without further notice.

1 absolute pressure possible from 0.6 bar

2 shielded TPE-U-cable with ventilation tube available in different lengths; cable not included in the price

3 optionally for nominal pressure ranges up to 400 bar and mechanical connections G1/2" DIN 3852, G1/2" EN 837, G1/2" open port, G1/4" DIN 3852, G1/4" EN837 in combination with housing in CuNi10Fe1Mn (not with field housing)



BD SENSORS s.r.o.
Hradištská 817
CZ – 687 08 Buchlovice

Tel.: +420 572 411 011
Fax: +420 572 411 497

www.bdsensors.cz
info@bdsensors.cz

The company BD SENSORS s.r.o. is certified by TÜV SÜD Czech according to the standard ISO 9001.

